

TELEVAC TELEVAC TELEVAC TELEVAC

INSTRUCTION MANUAL

MP4AR Remote Convection Gauge

Range: 1×10^{-3} Torr to $1 \times 10^{+3}$ Torr



TELEVAC
A DIVISION OF *THE FREDERICKS COMPANY*
2400 PHILMONT AVE.
HUNTINGDON VALLEY, PA 19006

PARTS LIST

1

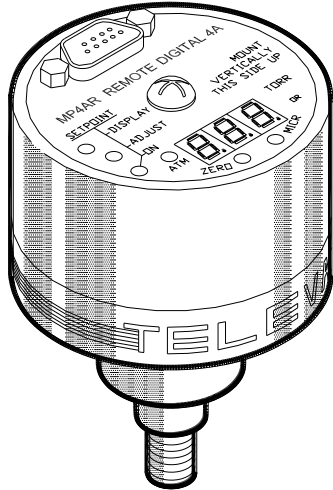

4

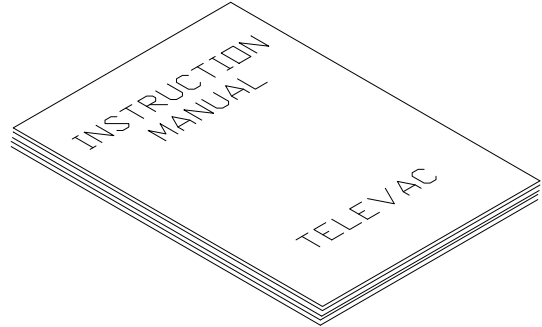

3

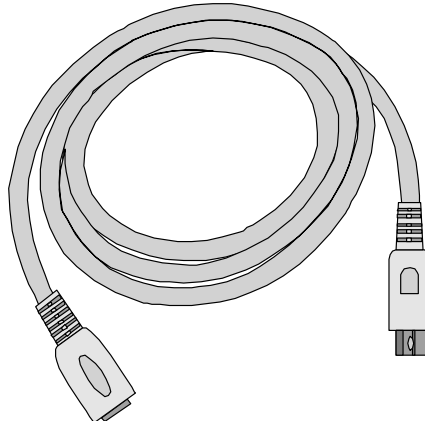

2

#	QTY	ITEM DESCRIPTION
1	1	4AR Remote Convection Electronics
2	1	Cable (specified at ordering)
3	1	Instruction Manual
4	1	Sensor

TABLE OF CONTENTS

<u>SECTION</u>	<u>TITLE</u>	<u>PAGE</u>
01.	DESCRIPTION and INSTRUMENT OPERATION	2
02.	SAFETY	3
03.	PRINCIPLES OF SENSOR OPERATION	4
04.	SENSOR OPERATION AND INSTALLATION	5
05.	RECORDER OUTPUTS	7
06.	MAINTENANCE	8
07.	CALIBRATION	8
08.	TROUBLESHOOTING	8
09.	SPECIFICATIONS	9
10.	DIMENSIONS	10
11.	UNPACKING AND INSPECTION	11
12.	WARRANTY INFORMATION	11

PLEASE READ THIS MANUAL THOROUGHLY BEFORE USING GAUGE. REPORT ANY PROBLEMS IMMEDIATELY.

Description and Instrument Operation

The MP4AR series Remote Module provides a compact stand-alone measurement solution for applications that do not require traditional panel-mounted instrument readouts. These modules can provide local readout and control or can be interfaced directly with a PLC, chart recorder, or data acquisition system. The MP4AR series of instruments use the time proven reliable and rugged TELEVAC 4A Sensor, which can be changed in seconds. These instruments operate from low voltage DC and are easily integrated into the largest process system with a minimal effort. Likewise, the MP4AR Remote Gauge can be used as a small stand-alone vacuum measurement solution.

Features

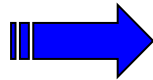

Wide range 1×10^{-3} Torr to 1×10^{-3} Torr



Sensors can easily and quickly be replaced if required

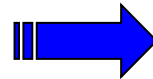

Compact & rugged self-contained package



Fast system control with one setpoint

Safety Instructions

START BY READING THESE IMPORTANT SAFETY INSTRUCTIONS AND NOTES collected here for your convenience and repeated with additional information at appropriate points in these instructions



These safety alert symbols in this manual or on the Product rear panel mean cautions - personal safety, property damage or danger from electrical shock. Read these instructions carefully.

In these instructions the word “**product**” refers to the **MP4AR** and all of its approved parts and accessories.

NOTE: These instructions do not and cannot provide for every contingency that may arise in connection with the installation, operation, or maintenance of this product. Should you require further assistance, please contact Televac at the address on the title page of this manual.

This product has been designed and tested to offer reasonably safe service provided in it's installed, operated and serviced in strict accordance with these safety instructions.



Failure to comply with these instructions may result in serious personal injury, including death, or property damage.

These safety precautions must be observed during all phases of operation, installation, and service of this product. Failure to comply with these precautions or with specific warnings elsewhere in this manual violates safety standards of design, manufacture, and intended use of the instrument. Televac disclaims all liability for the customer's failure to comply with these requirements.



The service and repair information in this manual is for the use of Qualified Service Personnel. To avoid shock, do not perform any procedures in this manual or perform any Servicing on this product unless you are qualified to do so.

- ✓ **READ Instructions** – Read all safety and operating instructions before operating the product.
- ✓ **RETAIN instructions** – Retain the Safety and Operating Instructions for future reference.
- ✓ **HEED warnings** – Adhere to all warnings on the product and in the operating instructions.
- ✓ **FOLLOW instructions** – Follow all operating and maintenance instructions.
- ✓ **ACCESORIES** – Do not use accessories not recommended in this manual as they may require a technician to restore the product to its normal operation.



To reduce risk of fire or electric shock, do not expose this product to rain or moisture.

Safety Instructions (cont.)



Objects and Liquid Entry – Never push objects of any kind into this product through openings as they may touch dangerous voltage points or short out parts that could result in a fire or electric shock. Be careful not to spill liquid of any kind onto the products.



Do not substitute parts or modify instrument.
Because of the danger on introducing additional hazards, do not install substitute parts or perform any unauthorized modifications to the product. Return the product to Televac for service and repair to ensure that safety features are maintained. Do not use this product if it has unauthorized modifications.

CHAPTER 3

Principles of Sensor Operation

The convection gauge measures absolute pressures by determining the heat loss from a thermocouple heated to a constant temperature by a current source. A second thermocouple compensates for ambient temperature changes and extends the vacuum measurement range above 2 Torr by measuring the convection effects.

The convection sensor must be mounted vertically for accurate measurements. Sensors are available in stainless steel or nickel-plated brass and can withstand 150-psi overpressure.

SENSOR OPERATION AND INSTALLATION

- 1.0 Connect the gauge to the vacuum system. **It must be mounted vertically with the stem side down.**

NOTE: DO NOT TURN INSTRUMENTATION WHEN MOUNTING ON A THREADED INSTALLATION TO INSTALL, USE A WRENCH ON THE FLATTED PORTION OF THE SENSOR TUBE

- 2.0 Assure that there are no leaks.
- 3.0 Apply 24 DC volt power between pin # 3 (+) and pin # 4 (-) of the connector cable.
- 4.0 Configure output lines; pin # 5 (for linear 1 T or log 1000T output), pin # 8 (signal gnd) and pin # 7 (for non linear output). The table of voltage versus pressure is shown in chapter # 5. The linear signal output is 10 volts at 1000 microns and decreases linearly to zero at zero microns. The non-linear signal output is 10 volts at atmospheric pressure and decreases non-linearly to zero volts at zero microns. If it is a log 1000T unit, the output decreases logarithmically from 6.0 volts at 1000Torr to zero volts at zero microns.
- 5.0 Pump down the vacuum system while observing the LED display and the signal voltage reading on the output. (see chapter # 5 for output values)
- 6.0 While the pressure is above 1000 Torr the display will show "HI". Below 1000 Torr the signal output will correspond to values given in chapter # 5, depending upon chosen output. As the pressure drops below 1 Torr the red "MICRONS" LED lights and the displayed readings now drop from 990 down to zero while the linear output voltage drops correspondingly from 9.90 Volts to zero.
- 7.0 The trip pressure for the setpoint relay can be displayed by pressing the "setpoint display" button on the front panel of the instrument or by reading the Set Point voltage at pin # 9 of the cable connector. The display will blink the reading until the button is pushed again or until it times out automatically after 60 seconds. If the Set Point adjustment screw is turned to change the setting the new value displayed will be retained in memory. The setpoint adjustment range is 0 to 1 Torr for the units with linear recorder output and 0-1000 Torr for units with logarithmic recorder outputs. The relay contact connections are as follows; to the common # 6, # 1, normally open, and # 2, normally closed.
- 8.0 If the display shows "-1" or "LO" then the gauge is out of adjustment. With a known vacuum of at least 1×10^{-5} Torr, adjust the "Zero" adjustment screw on the front panel.
- 9.0 With the sensor tube exposed to atmospheric pressure, the display reading should be near 760 Torr (which may vary with geographic location). Adjustment for the correct reading is done with the front panel "ATM" settings. Make sure that the tube is vertical, with stem down.

SEE NEXT PAGE FOR GAUGE DIAGRAMS

SENSOR OPERATION AND INSTALLATION (cont.)

PIN#	PIN OUTS
1	Relay normally open contact
2	Relay normally closed contact
3	+24 volt power
4	Power common
5	Log / Linear signal output
6	Relay common contact
7	Non-linear signal output
8	Signal return
9	Setpoint output

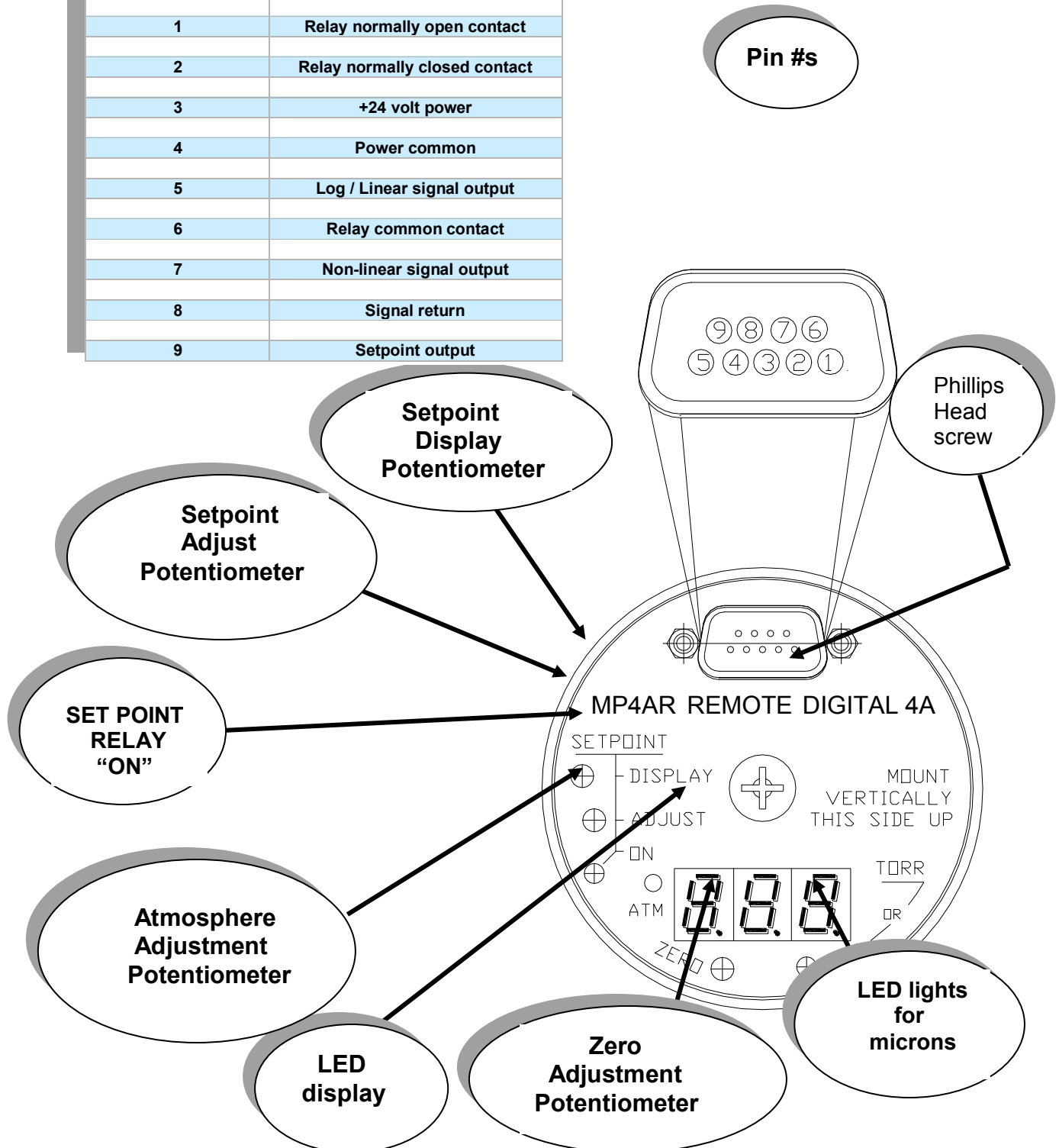

CHAPTER 5

TELEVAC

Recorder Outputs

LINEAR

Pressure (microns)	Voltage
1	.01
5	.05
10	.1
20	.2
30	.3
40	.4
50	.5
60	.6
70	.7
80	.8
90	.9
100	1
150	1.5
200	2
300	3
400	4
500	5
800	8
1000	10
2000	13.5

Non-linear & Logarithmic

Pressure (TORR)	Voltage (non-linear)	Voltage Logarithmic
1 x 10 ⁻³	.01	0
5 x 10 ⁻³	.06	.70
2 x 10 ⁻²	.24	1.3
4 x 10 ⁻²	.45	1.6
6 x 10 ⁻²	.64	1.78
8 x 10 ⁻²	.82	1.9
.1	.98	2
.2	1.67	2.3
.5	2.99	2.7
.8	3.84	2.9
2	5.45	3.3
10	7.32	4
30	7.84	4.48
50	7.93	4.7
80	8.01	4.9
120	8.08	5.08
160	8.19	5.2
180	8.24	5.26
300	8.76	5.48
500	9.57	5.7
760	10	5.88
1000	10.22	6

4AR (linear)

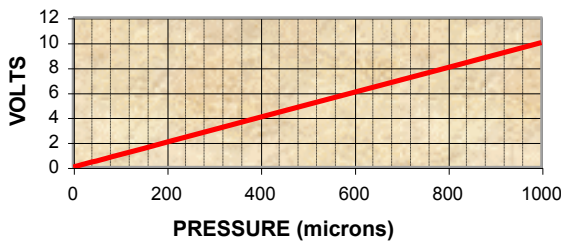

4A (Logarithmic)

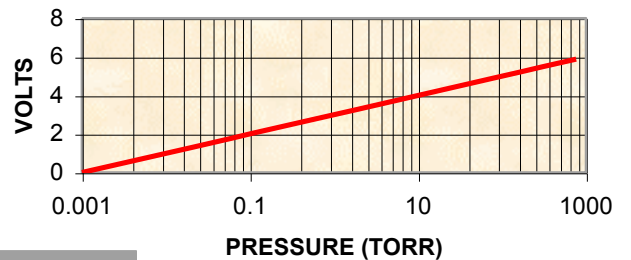

4A (non-linear)

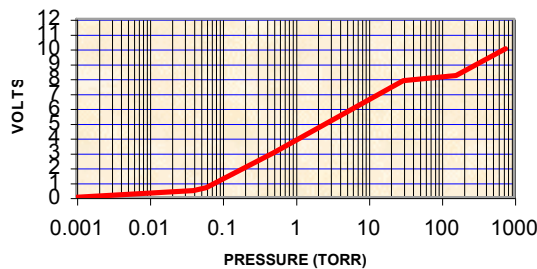

CHAPTER 6

TELEVAC

Maintenance

No maintenance is required beyond periodic replacement of a contaminated sensor. To replace the sensor, remove the Philips head screw in the center of the instrument, then gently rock and pull off the electronic assembly. Replace the old sensor with a new one, remount the electronics and replace the Phillips head screw. **DO NOT OVER TIGHTEN THE SCREW! Adjust the “ATM” screw for the proper reading when the vacuum system is vented.**

CHAPTER 7

Calibration

All instrumentation is calibrated at the factory. No further calibration at the customer's facility should be required, unless the gauge tube is replaced. In this instance the “ATM” adjustment should be done. No re-adjustment of the zero should be required unless it has been changed.

For a reliable recalibration at a later date, it is necessary to have a reference standard vacuum system whose pressure is known to be accurate. For such a calibration, the instrument, sensor tube and cable should be returned to the factory for re-certification. However, if the vacuum calibration verification must be done at the customer's facility, a knowledgeable electronics technician trained in vacuum calibration should operate equipment of certifiable accuracy.

CHAPTER 8

Troubleshooting

1. If display consistently displays “HI”, the atmosphere adjustment may be incorrect or there may be a broken filament in the sensor. If a broken filament is suspected, check for continuity between pins # 4 & # 8 and # 2 & # 6 on the sensor.
2. If the display constantly reads “LO”, the sensor may have become inoperative. Check for correct reassembly after bake out.

NOTE: If, after doing some or all of the above, the units are still inoperative, return to the factory for repair.

Specifications

Measurement range

1 x 10⁻³ to 1 x 10⁺³ Torr

Calibration Medium

Dry air or nitrogen

Materials

Stainless steel or nickel-plated brass

Overpressure

150-psi

Adjustment Potentiometers

Zero, Atmosphere, Setpoint

Response Time for a Pressure Change from 10⁻⁵ Torr to Atmosphere

< 500 milliseconds

Temperature

Operating +15° to + 50°C
Bake out at 200°C (with electronics removed)

Power

24VDC @ 100mA (customer supplied)

Set point Relay

Form C contact
24 v.5 a rating
Indicator lamp provided

Accuracy

+/- 1 micron	0 to 10 microns
+/-10% of reading	10 microns to 10 Torr
+/- 20% of reading	10 Torr to 100 Torr
+/- 10% of reading	100 Torr to 1000 Torr

Dimensions

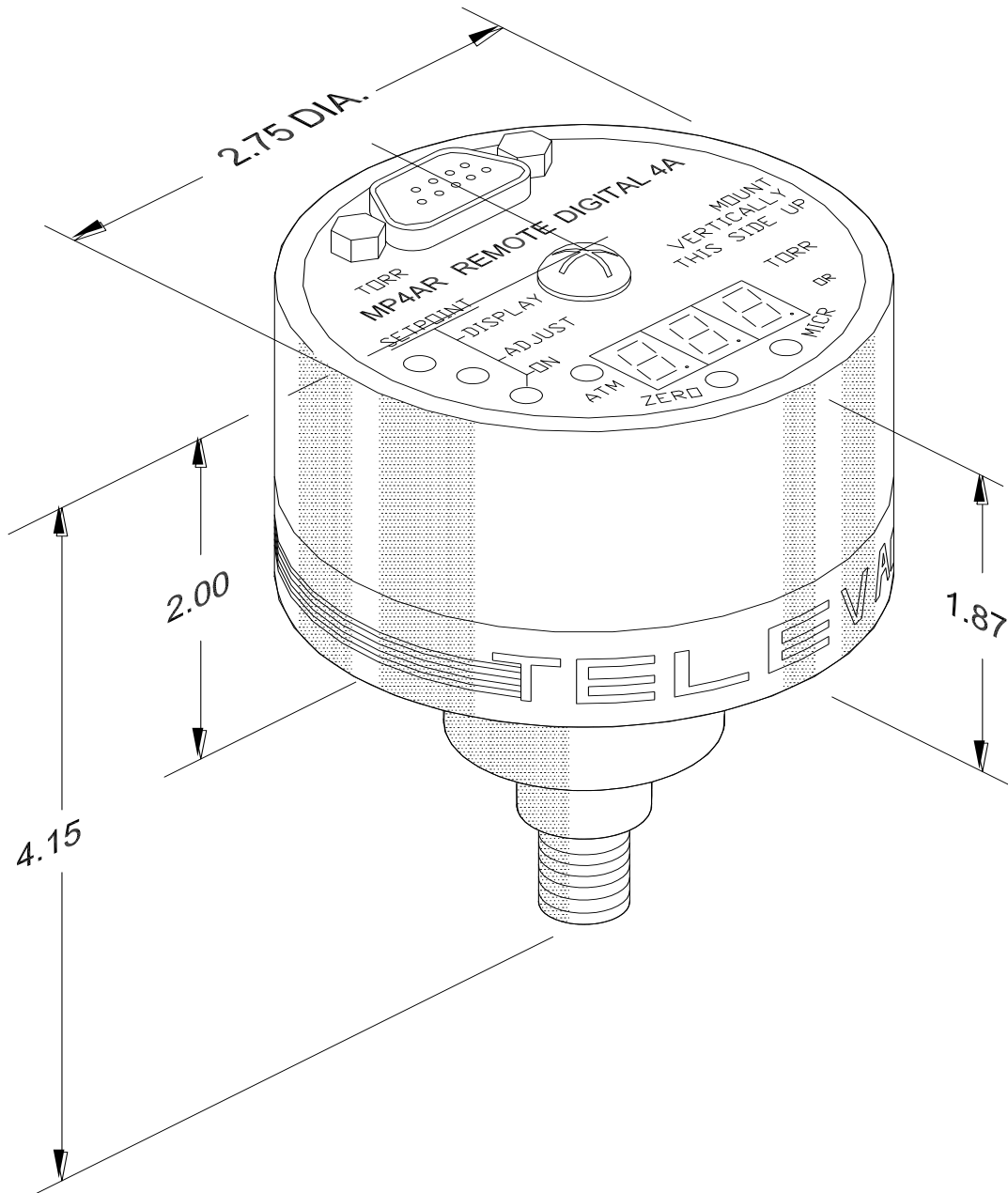

CHAPTER 11

TELEVAC

Unpacking and Inspection

Before each unit is installed or operated, a quick inspection should be performed and the following noted:

- a. damage to the unit (scratches, nicks, dents, cracks, etc.)
- b. missing: screws, switches or switch hardware
- c. broken barrier strips, etc.
- d. broken or loose components within instrument

Should any of the above problems be encountered, contact the factory immediately. Any unauthorized repairs will void the warranty.

CHAPTER 12

Warranty information

The Televac division warrants instruments and components to be free of defects in material and workmanship for a period of one year after the date of shipment unless otherwise specified in the quotation or product literature. No salesman, Representative or agent of the Fredericks Company, or its divisions is authorized to give any guarantee or warranty or make any representation in addition or contrary to those stated herein.

other than those expressly stated herein, **there are no other warranties of any kind, express or implied and specially excluded but not by way of limitation, are the implied warranties of fitness for a particular purpose and merchantability. It is understood and agreed the seller's liability whether in contract, in tort, under any warranty, in negligence or otherwise shall not exceed the return of the amount of the purchase price paid by the purchaser and under no circumstances shall seller be liable for special, indirect, incidental or consequential damages. The price stated for the equipment is a consideration in limiting seller's liability. No action regardless of form, arising out of transactions of this agreement may be brought by purchase more than one year after the cause of action has accrued, seller's maximum liability shall not exceed and buyer's remedy is limited to either (1) repair or replacement.**